

Infrared Digital Scouting Camera

User's Manual

Quick Start

1. Load the fully charged AA batteries, 12(recommended), 8 or 4(emergency); or connect 6 V external power supply;
2. Insert the SD card (32GB or smaller) and SIM card (Wireless cameras ONLY). Be sure that the PIN of the SIM card is disabled; (You can disable the PIN of a SIM card via your service provider.) (Wireless cameras ONLY)
3. Slide the power switch to the "SETUP" position to set up the camera;

Note: When going into the setup mode, allow approximately 10-20 seconds for the camera to acquire a signal. (Wireless cameras ONLY)

4. Press the "MENU" button to enter into the program menu, then press the "up" or "down" arrow buttons for parameter settings as described in the user's manual. Press the "OK" button to save parameter settings and exit;
5. Place the camera at the target area and turn on the camera (slide the power switch to "ON") , the camera will take pictures or videos as preset in step 4;
6. Press the "  "playback button to capture photos or record a video manually;
7. Press the "OK" button to playback the pictures. Use the "up" or "down" arrow buttons to scroll through pictures on the color monitor;
8. To delete an image in SETUP mode, press the

"playback" button to review the image and then press the "DEL" button to delete the image.

Key Notes

- a. "MENU": enter the program menu in preview mode;
- b. "▲▼◀▶": for parameter settings as described in the user's manual.
"▲" is the shortcut to choose "Video", while "▼" for the "Camera".
- c. "OK": save parameter settings and play videos.
- d. "▶": exchange between playback and preview ;
- e. "DEL": delete an image
- f. "📷": capture a photo or record a video manually.
- g. Switch: OFF in the left; SETUP in the middle; ON in the right position.
- h. DC plug in diameter: 4.0mm*1.7mm.

1 Instruction

1.1 General Description

This camera, is a digital infrared surveillance camera, triggered by any movement of humans or animals monitored by a high sensitive Passive Infrared (PIR) motion sensor, and then automatically captures high quality pictures (up to 8M pixels(Interpolated), real 5M pixels) or records video clips (VGA) according to default settings or preset customer settings. The wireless version cameras can send the pictures instantly to your mobile device or e-mail via GSM/GPRS network. You'll be alerted just when the camera is triggered or per custom settings.

It takes color pictures or videos under sufficient daylight. While at night, the built-in infrared LED's take clear pictures or videos (monochrome).

There is a 2.0" color LCD display screen on the camera and a sound recorder embedded in the camera.

It is resistant against water and snow. The camera can also be used as a portable digital camera.

1.2 Camera Body Interfaces

The camera has the following I/O interfaces: USB connector, SD-card slot and external DC power connector.

On the back of camera, there is a lock for theft-proof and an adjuster to change the tilt when mounting on an irregular interface e.g. tree.

Take a few moments to familiarize yourself with the camera controls and displays. It is helpful to bookmark this section and refer to it when reading through the rest of the manual.

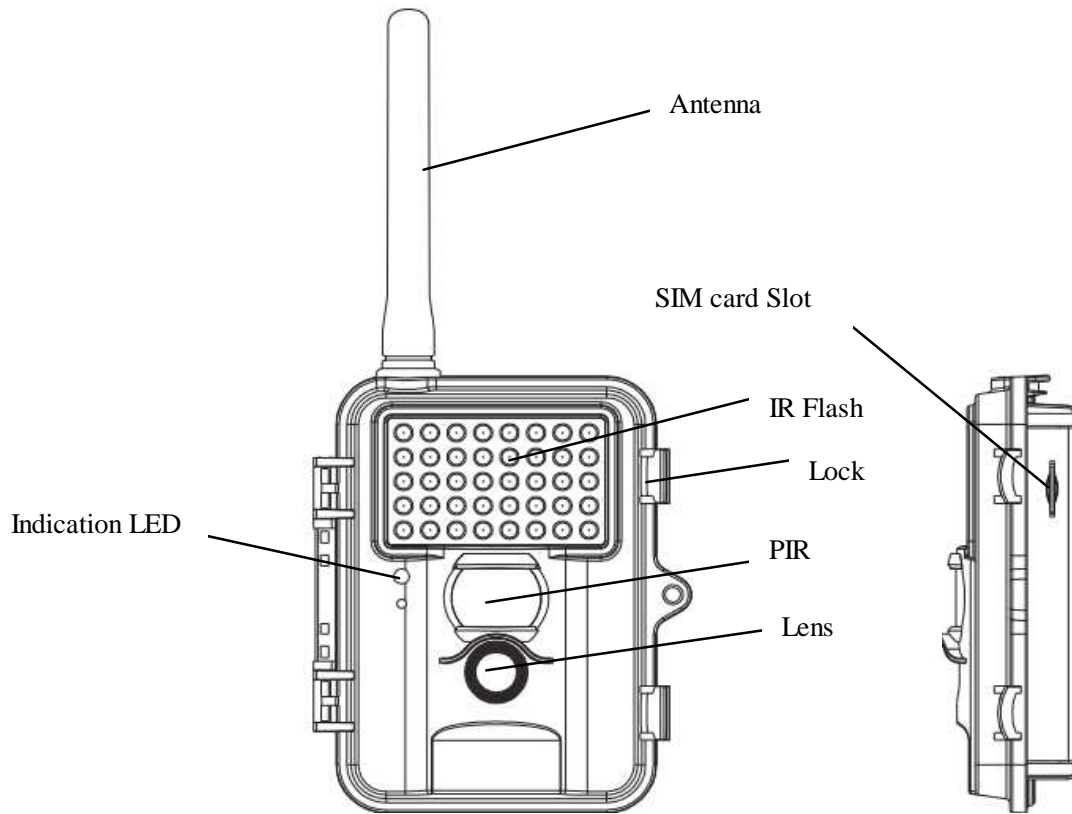

Figure 1: Front View

Remarks:

- 1. Antenna for wireless camera ONLY**
- 2. SIM card Slot for wireless camera ONLY**

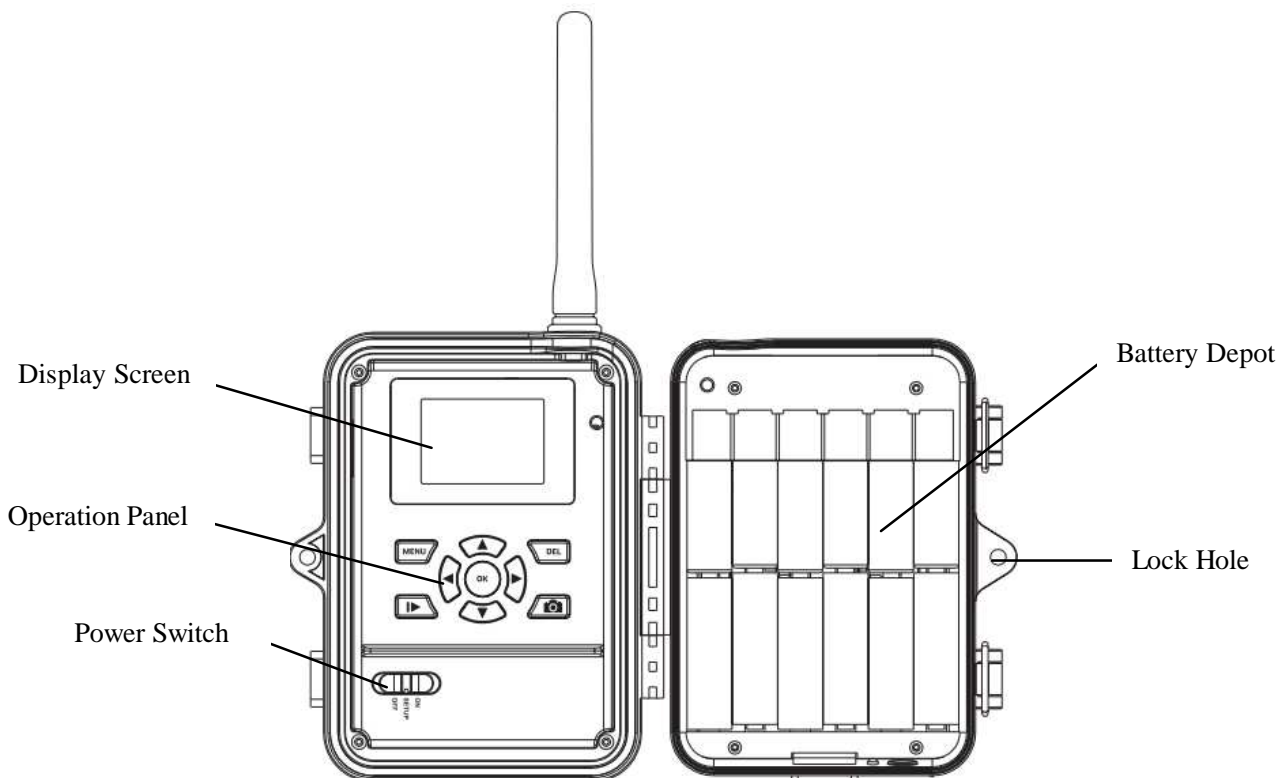

Figure 2: Operation Interface

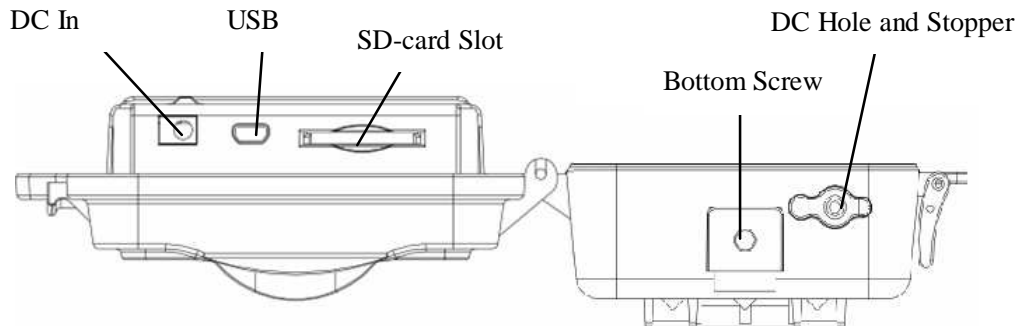

Figure 3: Bottom view

1.2.1 Key Notes

- a. **"MENU"**: enter the program menu in preview mode;
- b. **"▲▼◀▶"**: for parameter settings as described in the user's manual.
- "▲"** is the shortcut to choose **"Video"**, while **"▼"** for the **"Camera"**.
- c. **"OK"**: save parameter settings and play videos.
- d. **"▶"**: exchange between playback and preview;
- e. **"DEL"**: delete an image
- f. **"📷"**: capture a photo or record a video manually.
- g. Switch: OFF in the left; SETUP in the middle; ON in the right position.
- h. DC plug in diameter: 4.0mm*1.7mm.

1.3 MMS function(For Wireless type ONLY)

Wireless version camera can send pictures instantly to your mobile device via GSM/GPRS network. You'll be alerted just when a picture or video has been taken. The camera sends MMS message through GPRS network, so before using this function, you need to open GPRS service from your service provider. It supports four band : 850MHz, 900MHz, 1800MHz and 1900MHz. Pls insert SIM card correctly.

Be sure that the PIN of the SIM card is disabled before inserting the SIM card. (You can disable the PIN of a SIM card via your mobile phone.) Then reinsert the card into your camera.

2. Quick Start Guide

2.1 Power Supply

To supply power for the camera, 4, 8 or 12 size AA batteries are needed.

Confirm that the power switch is in the **OFF** position; load the fully charged batteries into the pack according the polarities signs shown below. The following batteries with 1.5V output can be used:

1. High-density and high-performance alkaline batteries (Recommended)
2. Rechargeable alkaline batteries
3. Rechargeable NiMH batteries

There are 6 battery slots. Slot 1 and 2 form one group and is marked "1", slot 3 and 4 form the other group and is marked "2", while slot 5 and 6 form the other group and is marked "3". Only one "group" of batteries is needed to supply power to the camera, but both can be used and is recommended.

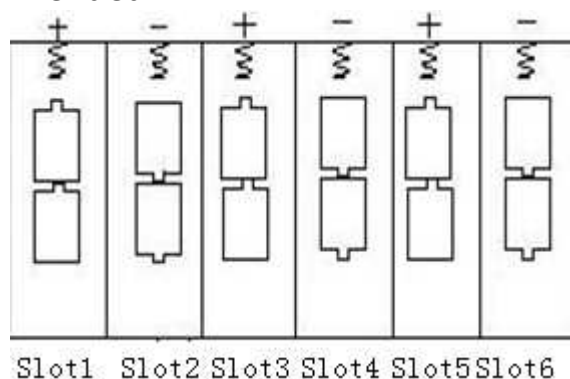

2.2 Insert the SD-card and the SIM-card(wireless cameras ONLY)

Open the bottom cover. Insert an SD-card into the card slot with unmarked side upwards. Please note that the SD-card is on the "write" (not locked) position otherwise the camera will not function correctly. When using MMS/SMS/E-mail functions, be sure to insert a SIM-card into the SIM-card slot with angle in the upper left.

2.3 Power on and Enter into the ON Mode

Before switching on, please pay attention to the following:

1. Avoid temperature and motion disturbances in front of the

camera such as a big leaf, curtain, air-conditioner, air outlet of the chimney and other heat sources to prevent from false triggering.

2. The height from the ground for placing the camera should vary with the object size appropriately. In general, **three to six feet** is preferred.

Slide the power switch to the **ON** position to power on the camera and enter into the **ON** mode.

2.4 Enter into the SETUP Mode

Slide the power switch to the **SETUP** position and enter into the **SETUP** mode. There are some functions in **SETUP** mode: Custom settings, manual capture, preview or send MMS manually.

2.4.1 Custom Settings

Press **MENU** on the user interface to enter into the menu setting. The camera can be adjusted to manually customize the camera settings which display on the LCD screen on the camera. The detailed operations will be described in the "Advanced Operations" chapter.

2.4.2 Manual Capturing

You can press  to manually capture photos or record a video.

2.4.3 View Images or Videos

Use LCD screen to view the captured images or videos:

Press  to view images, the latest image or video will be shown in the LCD screen on the camera. Press **UP** to view the previous image and press **DOWN** for the next.

The detailed operations like deleting images or videos will be described in the "Advanced Operations" chapter.

2.4.4 Send MMS(Wireless cameras only)

The detailed operations like deleting images or videos will be described in the "Advanced Operations" chapter.

2.5 Power Off

Slide the power switch to the **OFF** position to power off the camera. Please note that even in the **OFF** mode, the camera still consumes a small amount of battery power. Therefore, please remove the batteries if the camera is not in use for some time.

3 Advanced Operations

Settings Menu and Default Settings

To view the camera settings menu, switch the camera to **SETUP** mode and press **MENU**, the main menu and the default settings are under below charts:

Main menu



Setting Items		Description
CAM	Camera Mode	Choose Photo or Video.
	Photo Size	Choose the image size, e.g. 5MP,8MP or 3MP.
	Photo Burst	Choose the continuous shooting numbers after each triggering.
	Video Size	Choose the video size
	Video Length	Set the video length as of required
PIR	Sensitivity	High, Low ,Normal selectable
	Trigger Interval	The duration the camera will stop functioning after each triggering.
	Time Lapse	The camera can be set to record/capture at a certain time of the day as of requested. While if Time Lapse is set to Off, the camera works only by PIR triggering.
	Start-Stop	Start-stop " On " means that the camera works by PIR triggering; Start-stop " Off " means that the camera PIR stops working.
GSM (Wireless cameras only)	Send Mode	There are 3 MMS mode: Daily report, Instant and OFF .
	Send Via	MMS and GPRS selectable
	Send To	Enter the phone number or email where the MMS is to be sent. Phone, Email and Both .
	Recipients	Press "Enter" to review what you have set to receive the MMS or GPRS pictures.
	Location	Press enter to get the Longitude& Latitude information.(show only in the display screen)
	Download Tool	Pls refer to the Advanced Chapter for details
SYS	Set Clock	Enter to set the Date and Time

Time Stamp	Choose "On" or "Off" to show the time on the picture or not.
Flash Range	Infrared Flash range: .20 ft./6m and 40 ft./12m
Password	The default password is 0000 . Choose OFF to stop this function.
Language	English (Preset) , we provide the choice for customer to choose the language, pls contact your distributor for assistance.
Beep	Customer can choose ON/OFF when operating the cameras.
Overwrite	ON/OFF, if choose "ON" The camera writes off the previous taken pictures and continues to record new pictures/videos, thus, the SD-card is recyclable, customer needs not to change SD card frequently.
Default Set	Restore all customer settings to default values.
Format	Format the SD-card.

Press **LEFT** or **RIGHT** and **UP** or **DOWN** to select the desired value, And then press **OK** to save.

4 Playback

4.1. Viewing Photo or Video

- Switch to **SETUP** mode;
- Press  to view the latest picture (or video) in LCD screen on camera;
- Press  to start playing the video clips;
- Press  **again** to stop playing and return to playback mode.
- Press **UP** to view the next picture (or video) and **DOWN** for the previous.

4.2. Delete Photo or Video

- Press  to view the image (or video) which to be deleted;

- b) Press **DEL** button;
- c) Press **LEFT** or **RIGHT** to select Yes to execute or No to Exit;

Please note that after deleting a picture or a video file, the deleted files can't be restored!

4.3. File Numbering

Images and videos are saved in the pre-named folder. File numbering continues by adding one to the last number for each new image or video. Saving names are IMAG0001.JPG or IMAG0001.AVI. Through the suffix you can distinguish whether the file is an image (with suffix .jpg) or a video (with suffix .avi).

5. Firmware Upgrading

This camera is equipped with an automatic upgrade function for you. Upgrading is needed only when an improved firmware is available. And pls contact the local dealers or distributors for further information.

Appendix I: Technical Specifications

Picture Resolution	8MP (Interpolated) , Real 5MP
Lens	F/NO=3.0 FOV(Field of View)=52°
IR-Flash	6-12m
Display Screen	2.0" LCD
Memory Card	From 8 MB to 32GB
Video Resolution	VGA(16fps) ; QVGA(20fps)
PIR Sensor	Multi Zone
PIR Sensitivity	Adjustable (High/Normal/Low)
Trigger Time	1.2s
Weight	0.35 kg
Operation/Storage Tem.	-20 - +60°C / -30 - +70°C
Interval	1s – 60 min.
Photo Burst	1–3
Video Length	1–60s
Power Supply	4×AA, 8×AA or 12AA
Stand-by Current	< 0.25 mA (<6mAh/Day)
Power Consumption	600 videos (interval=5min,video length=10s) ; >800 MMS(use 12*AA batteries)
Low Battery Alert	LED Indicator
Display Screen	LCD display on camera
Sound Recording	Un-available
Mounting	Rope/Belt/Python lock
Dimensions	140 x87 x55 mm
Operation Humidity	5% - 90%
Security authentication	FCC, CE, RoHS

*without battery

Appendix II: Parts List

Part Name	Quantity
Digital Camera	One
USB Cable	One
Belt	One
User Manual	One
Antenna	One(Wireless camera only)

The camera manufacturer provides 24 months of warranty service for this product against manufacturing defects or malfunctions. If your camera fails to function under normal use within 2 years, the camera manufacturer will repair or replace the camera at no charge. The **purchase receipt must be included from an authorized retailer to validate the warranty.** Improper use of the camera resulting in damage is not covered by this warranty.

The camera manufacturer can provide repair service, after the warranty expiration. The customer will be responsible for any charges on parts, labor and shipping costs. Please contact the manufacturer for more details.

Declaration of Conformity to Directive 1999/5/EC

CE Caution :

Hereby, the manufacturer declares that this camera is in compliance with the essential requirements and other relevant provisions of Directive 1999/5/EC. Pls ask for your distributor for a copy of the **Declaration of Conformity to Directive 1999/5/EC.**